

1. FEATURES

The Model QR-6FM (option) is designed to be used with the Model QR-666 to receive broadcast of FM band covering the frequency range of 87.5 ~ 108MHz.

- The front end circuit is provided with a specially designed 4-gang variable capacitor mounted in a compact metallic case that offers complete shielding effects, thus improving image ratio and IF rejection as well as minimizing spurious radiations.
- The IF section employs ceramic filter and high gain IC for easy assembly and adjustments, and for superior selectivity.
- The tuning mechanism of a vernier-shaft/bevel-gear construction permits preset tuning individually for FM and AM.
- No modification is required on QR-666 for operation with QR-6MK.

2. PARTS LIST

Before assembling, check to make sure that the following parts are included in the QR-6FM kit.

Names of Parts	Parts Numbers	Q'ty
Instruction manual	B50-1401-00	1
Alignment tool	W01-0070-05	1
FM (front) unit	L60-0027-05	1
Connector (3P) (With coaxial cable)	E09-0315-05	1
Socket (10P)	E10-1004-05	1
Cable wrapping band	J61-0019-05	6
Bind screw (3 x 6)	N35-3006-15	7
Brazer tap tight screw (3 x 6)	N87-3006-41	4
Brazer tap tight screw (3 x 10)	N7-3010-41	2
Plated wire	001-0801-05	25 cm
Lead wire (White)	011-6911-05	40 cm
Lead wire (Brown-White)	011-6911-05	95 cm
Shield wire (Black)	053-1001-15	75 cm
Shield wire (Green)	053-1501-15	75 cm
Coaxial cable	061-1501-05	40 cm
Shrink tube	212-0402-05	20 cm
Solder	Sn60Pb 1.2φ	100 cm
Tuning knob B	K21-0273-04	1
Tuning knob A	K20-0132-04	1
Bevel gear	D13-0028-04	2
Vernier shaft	D20-0081-33	1
Pointer	B08-3008-04	1
(Shaft) joint	B09-0003-05	1
Shaft	D21-0330-14	1
Bearing	D23-0061-04	1
Hexagonal boss	J32-0117-04	2
Jig for knob screws	W01-0065-04	1
Speed nut (Stopper ring)	N14-0074-05	1
Lock washer	N17-1030-31	9
Screw (Speed nut)	N09-0156-04	1
Back cover	F19-0141-04	1
Tuner mounting hardware	J21-117B-03	1
IF unit	X48-1110-21	1

3. ASSEMBLY AND WIRING
3.1 Assembly of FM Tuner Portion

- Provisionally attach the bevel gear to the FM tuner and fix it to the tuner mounting hardware.
- Fasten the blind plate to a chassis with the vernier shaft.
- Attach the shaft joint to the vernier shaft.
It should be attached with a gap of approximately 0.5 mm so that the head of screw may not touch with the vernier.
- Fit the bearing in a tuner mounting hardware.
- Set the shaft to the bearing and put on the bevel gear and fasten with screws of the shaft joint.
- Fasten by adjusting set screws so that the tooth portion of two bevel gears engage with each other.
- Ascertain that the tuner variable capacitor rotates with smooth by turning the vernier shaft.

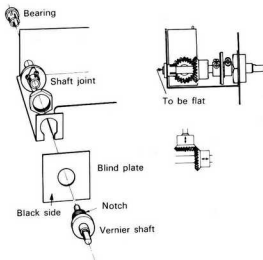
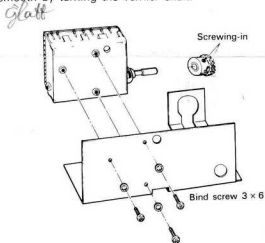

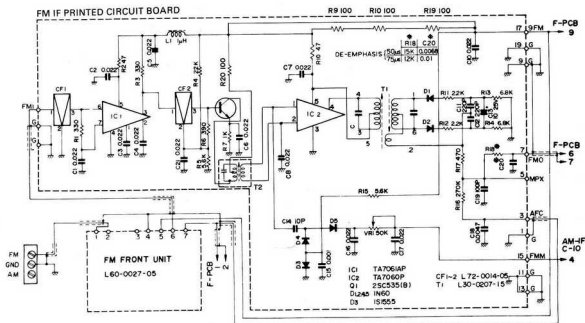

* Attach the assembled FM tuner portion to the main body (QR-666).

- If the marker unit (QR-6MK) has been already installed, disconnect one side of a red/white lead wire temporarily and pass through under the shaft joint.

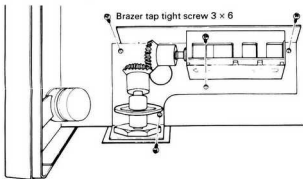

3.2 Mounting of 10-pin Connector Socket

Set the socket in place so that No. 1 terminal is located at the rear panel side. (Opposite side of AF/PS unit)

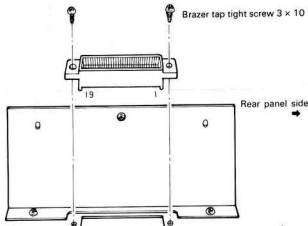

3.3 Preliminary Steps for Assembly of Printed Circuit Board

Perform a solder plating to two places specified in the drawing. Attach the hexagon boss to the places where the soldering is performed.

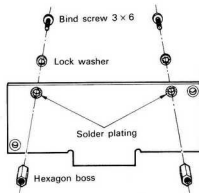

4. WIRING OPERATIONS

4.1 Preparatory Working of Wire Materials

Unit (mm)

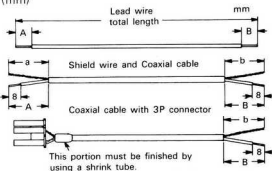

Wire materials	Total length	Length to be stripped			
		A	B	A	B
White lead wire	300	8	8		
Brown/White lead wire	750	8	8		
Brown/White lead wire	180	8	8		
Black shield wire	720	A	a	B	b
Green shield wire	550	20	20	30	20
Green shield wire	170	20	20	30	20
Black coaxial cable	280	20	20	20	10
Coaxial cable with 3P connector	230	—	—	20	20

4.2 Wiring Operations of Each Part

Bind No. 19, 13, 11, 9 and 1 terminals of the IF connector socket A and an earth tongue with a tin-plated wire and perform the soldering to the terminals 19, 13 and 9 and the earth tongue. Perform soldering at the positions marked ★
Wrap the lead wires around the terminals at the positions without ★ marking.

IF connector A15 ★
→ White lead wire 300 mm
→ IF connector B7 ★

For convenience sake, the IF connector socket is called as IF connector.

IF connector A17 ★
→ Brown/White lead wire (750 mm)
→ Switch unit 9 ★

Switch unit 9 ★/2
→ Brown/White lead (180 mm)
→ FM tuner 5 ★

IF connector A7 ★ → Core of black shield wire (720 mm)
→ Switch unit 6 ★

IF connector A11 ★ → Earth side of black shield wire (720 mm) → Switch unit 7 ★

IF connector A3 ★ → Core of green shield wire (550 mm)
→ FM tuner 7

IF connector A1 ★/2 → Earth side of green shield wire (550 mm) → FM tuner 4

Switch unit 2 ★ → Core of green shield wire (170 mm)
→ FM tuner 7 ★/2

Switch unit 1 ★ → Earth side of green shield wire (170 mm)
→ FM tuner 4

Antenna terminal (3 pins) 3 ★ → Core of black coaxial cable (280 mm) → FM tuner 2 ★

Antenna terminal (3 pins) 2 ★ → Earth side of black coaxial cable (280 mm) → Frame of FM tuner ★

3P connector (Already wired) → Core of coaxial cable (230 mm) → FM tuner 6 ★

3P connector (Already wired) → Earth side of coaxial cable (230 mm) → FM tuner 4 ★/3

This coaxial cable should be passed through under the shafts of the main and spread variable capacitor.

4.3 Wire Binding

Binding should be performed with a vinyl tie at six places indicated in the drawing.

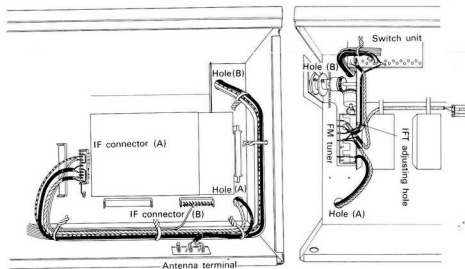

5. Adjustments

5.1 Caution on Adjustments

Only the IFT and the discriminator coils should be adjusted since the RF portion of the FM tuner unit has been already adjusted completely.

5.2 Preparation

Insert the IF unit into the 10P connector socket and the coaxial cable with a 3-pin connector into the 3-pin terminal (G. FM1), respectively.

FUNCTION FM BC
FM AFC OFF

5.3 Adjustment of the IFT and Discriminator Coils

Connect the FM antenna and adjust the IFT of FM tuner and of IF unit so that the maximum deflection is obtained in the S-meter, while receiving radio broadcasting correctly.

★ The VR1 (50kΩ) should be adjusted when the meter deflection is too excessive or insufficient.

The sound volume should be maximized by turning the core (inner side) at the primary side of the discriminator coil.

5.4 Adjustment of the Secondary Side of Discriminator Coil

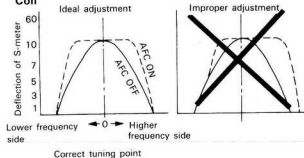

Slightly shift the reception frequency to higher side to reduce the deflection of S-meter.

Return the deflection of S-meter to its initial position by turning on the FM AFC switch and rotating the core at the secondary side of the discriminator coil.

Similarly slightly shift the reception frequency to lower side after turning off the AFC and return the deflection of S-meter to its initial position by turning on the AFC and rotating the core at the secondary side of the discriminator coil.

Thereafter, widen the range of reception frequency to be shifted little by little and adjust repeatedly so that the meter is returned under almost similar condition in both directions. Receive the most strongest broadcasting signal wave and adjust the VR1 (50k Ω) so that the meter deflection is up to full scale.

5.5 Adjustment of the Secondary Side of Discriminator Coil by Using a Circuit Tester or the Like

Adjust the meter needle of circuit tester to center zero and set to "DC 3V" range.

Connect the circuit tester to the detection output FMO (10-pin connector socket 7) of the FM IF unit and the earth circuit or chassis.

Receive a radio broadcast and seek a tuning so as to obtain the maximum deflection of S-meter.

Adjust the core at the secondary side of the discriminator coil so that the needle of the circuit tester remains at the "0" position.

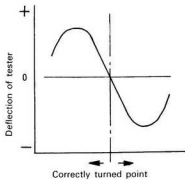

6. MOUNTING OF FM/IF UNIT

Remove the AF/PS unit temporarily and fix the FM/IF unit with two screws.

Mount the AF/PS unit in place.

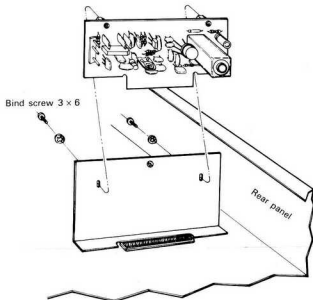

7. MOUNTING OF POINTER

Insert the ornamental window into the case and fix it by means of the stopper ring.

8. MOUNTING OF TUNING KNOB

Insert the tuning knobs A and B into place as follows.

Fix the knob screw by using a accessory tool.

After receiving the desired radio broadcasting, adjust the frequency of the broadcasting station and numerals on the tuning knob A to the pointer and then tighten the screw of the tuning knob A.

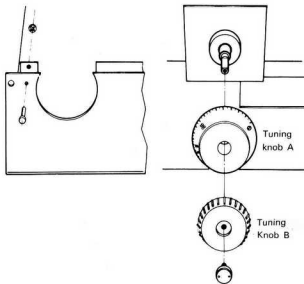

9. HOW TO MAKE T-TYPE FM ANTENNA (SHORT-DISTANCE)

Materials: 300 Ω feeder (Not supplied as accessory)

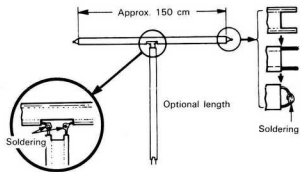

This antenna should be fixed with wood screws or nails at both sides after determining the most effective direction by turning 180 degrees while maintaining the upper portion of the antenna at level.

When the T-type FM antenna is found to be ineffective, that is, it is located far from broadcasting stations or behind a building, a FM antenna comprising 5 ~ 7 elements should be installed at as higher place as possible.